



( ) Preliminary Specifications

(✓) Final Specifications

Module	15.6" FHD Color TFT-LCD
Model Name	G156HAN02.0
Note	LED backlight with driving circuit design

<p><b>Customer</b>                      <b>Date</b></p> <p>_____</p> <p><b>Checked &amp; Approved by</b>                      <b>Date</b></p> <p>_____</p>	<p><b>Approved by</b>                      <b>Date</b></p> <p><u>Sean Lin</u>                      <u>11/23/2020</u></p> <p><b>Prepared by</b>                      <b>Date</b></p> <p><u>Robert Hsieh</u>                      <u>11/23/2020</u></p>
<p>Customer's sign back page</p>	<p>General Display Business Unit / AU Optronics corporation</p>



## Contents

<b>1. Handling Precautions .....</b>	<b>5</b>
<b>2. General Description .....</b>	<b>5</b>
2.1 General Specification .....	6
2.2 Optical Characteristics .....	6
<b>3. Functional Block Diagram .....</b>	<b>10</b>
<b>4. Absolute Maximum Ratings .....</b>	<b>11</b>
4.1 Absolute Ratings of TFT LCD Module .....	11
4.2 Absolute Ratings of Environment .....	11
<b>5. Electrical Characteristics .....</b>	<b>12</b>
5.1 TFT LCD Module .....	12
5.2 Backlight Unit .....	15
<b>6. Signal Interface Characteristic .....</b>	<b>16</b>
6.1 Pixel Format Image .....	16
6.2 Integration Interface Requirement .....	17
6.3 Interface Timing .....	19
6.4 Power ON/OFF Sequence .....	19
<b>7. Panel Reliability Test .....</b>	<b>22</b>
<b>8. Mechanical Characteristics .....</b>	<b>24</b>
8.1 LCM Outline Dimension (Front View) .....	24
8.2 LCM Outline Dimension (Rear View) .....	25
<b>9. Shipping and Package .....</b>	<b>26</b>
9.1 Shipping Label Format .....	26
9.2 Carton Package .....	27
9.3 Shipping Package of Palletizing Sequence .....	27
<b>10. Handling guide .....</b>	<b>28</b>
<b>11. Appendix: EDID Description .....</b>	<b>30</b>

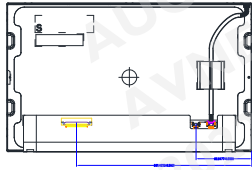
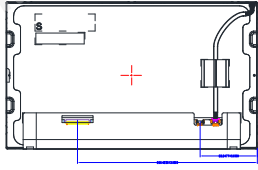

**Record of Revision**

Version	Date	Page	Old description	New Description																																																																																																																				
0.0	2016/08/29	All	First Edition for Customer																																																																																																																					
0.1	2016/10/21	5	Support Color 16.7M colors (RGB 8-bits data driver) Thickness 8.3 (Typ.)	→16.2M colors (RGB 6-bits + FRC data) →8.8 (Typ.)																																																																																																																				
		23	LCM Outline Dimension (Front View)	Update																																																																																																																				
		24	LCM Outline Dimension (Rear View)	Update																																																																																																																				
1.0	2017/03/20	5	LCD Power Consumption 2.7(Max.) LED Power Consumption 12.2(Max.)	→0.98(Max.) →10.4(Max.)																																																																																																																				
		6	Color / Chromaticity Coordinates Rx/Ry;Gx/Gy;Bx/By : TBD	→Value as below <table border="1"> <thead> <tr> <th></th> <th>Min.</th> <th>Typ.</th> <th>Max.</th> </tr> </thead> <tbody> <tr> <td>Rx</td> <td>0.590</td> <td>0.640</td> <td>0.690</td> </tr> <tr> <td>Ry</td> <td>0.283</td> <td>0.333</td> <td>0.383</td> </tr> <tr> <td>Gx</td> <td>0.252</td> <td>0.302</td> <td>0.352</td> </tr> <tr> <td>Gy</td> <td>0.578</td> <td>0.628</td> <td>0.678</td> </tr> <tr> <td>Bx</td> <td>0.107</td> <td>0.157</td> <td>0.207</td> </tr> <tr> <td>By</td> <td>0.000</td> <td>0.050</td> <td>0.100</td> </tr> </tbody> </table>		Min.	Typ.	Max.	Rx	0.590	0.640	0.690	Ry	0.283	0.333	0.383	Gx	0.252	0.302	0.352	Gy	0.578	0.628	0.678	Bx	0.107	0.157	0.207	By	0.000	0.050	0.100																																																																																								
			Min.	Typ.	Max.																																																																																																																			
		Rx	0.590	0.640	0.690																																																																																																																			
		Ry	0.283	0.333	0.383																																																																																																																			
Gx	0.252	0.302	0.352																																																																																																																					
Gy	0.578	0.628	0.678																																																																																																																					
Bx	0.107	0.157	0.207																																																																																																																					
By	0.000	0.050	0.100																																																																																																																					
11	IDD : 650 (Typ.); 891 (Max.) PDD: 2.15 (Typ.); 2.7 (Max.)	→240 (Typ.); 290 (Max.) →0.79 (Typ.); 0.98 (Max.)																																																																																																																						
14	5.2.1 LED characteristics PLED: - (Typ.);12.2 (Max.)	→8.3 (Typ.);10.4 (Max.)																																																																																																																						
1.1	2017/07/20	5	Surface Treatment Anti-Reflection ≤ 1.5%, hardness 2H	→ Anti-glare, 3H																																																																																																																				
		5	Temperature Range Operating -10 to +60 Storage (Non-Operating) -20 to +60	→-20 to+70(+70Caspanelsurface temp.) →-20 to +70																																																																																																																				
		10	4.2 Absolute Ratings of Environment Operating:-10(Min)+60(Max) Storage Temperature: -20(Min)+60(Max)	→-20(Min)+70(Max) →-20(Min)+70(Max)																																																																																																																				
		22	High Temperature Operation Ta= 60°C, Dry, 300h Low Temperature Operation Ta= -10°C, 300h High Temperature Storage Ta= 60°C, 300h	→Ta= 70°C, Dry, 300h (For panel surface temp.) →Ta= -20°C, 300h →Ta= 70°C, 300h																																																																																																																				
1.2	2018/01/22	7	2.2 Optical Characteristics <table border="1"> <thead> <tr> <th colspan="2"></th> <th>Red<sup>d</sup></th> <th>Bx<sup>e</sup></th> <th></th> <th>0.590 ±</th> <th>0.640 ±</th> <th>0.690 ±</th> </tr> </thead> <tbody> <tr> <td rowspan="3">Color / Chromaticity Coordinates (IEC 1931)<sup>a</sup></td> <td>Green<sup>b</sup></td> <td>Ry<sup>c</sup></td> <td></td> <td></td> <td>0.283 ±</td> <td>0.333 ±</td> <td>0.383 ±</td> </tr> <tr> <td></td> <td>Gx<sup>c</sup></td> <td></td> <td></td> <td>0.252 ±</td> <td>0.302 ±</td> <td>0.352 ±</td> </tr> <tr> <td>Blue<sup>b</sup></td> <td>Gy<sup>c</sup></td> <td></td> <td></td> <td>0.578 ±</td> <td>0.628 ±</td> <td>0.678 ±</td> </tr> <tr> <td></td> <td>Bx<sup>e</sup></td> <td></td> <td></td> <td>0.107 ±</td> <td>0.157 ±</td> <td>0.207 ±</td> </tr> <tr> <td></td> <td>By<sup>e</sup></td> <td></td> <td></td> <td>0.000 ±</td> <td>0.050 ±</td> <td>0.100 ±</td> </tr> <tr> <td></td> <td>Ww<sup>e</sup></td> <td></td> <td></td> <td>0.2630</td> <td>0.313<sup>a</sup></td> <td>0.363<sup>a</sup></td> </tr> <tr> <td>White<sup>b</sup></td> <td>Wy<sup>e</sup></td> <td></td> <td></td> <td>0.279<sup>a</sup></td> <td>0.329<sup>a</sup></td> <td>0.379<sup>a</sup></td> </tr> </tbody> </table>			Red <sup>d</sup>	Bx <sup>e</sup>		0.590 ±	0.640 ±	0.690 ±	Color / Chromaticity Coordinates (IEC 1931) <sup>a</sup>	Green <sup>b</sup>	Ry <sup>c</sup>			0.283 ±	0.333 ±	0.383 ±		Gx <sup>c</sup>			0.252 ±	0.302 ±	0.352 ±	Blue <sup>b</sup>	Gy <sup>c</sup>			0.578 ±	0.628 ±	0.678 ±		Bx <sup>e</sup>			0.107 ±	0.157 ±	0.207 ±		By <sup>e</sup>			0.000 ±	0.050 ±	0.100 ±		Ww <sup>e</sup>			0.2630	0.313 <sup>a</sup>	0.363 <sup>a</sup>	White <sup>b</sup>	Wy <sup>e</sup>			0.279 <sup>a</sup>	0.329 <sup>a</sup>	0.379 <sup>a</sup>	Update Value <table border="1"> <thead> <tr> <th colspan="2"></th> <th>Red<sup>d</sup></th> <th>Bx<sup>e</sup></th> <th></th> <th>0.589 ±</th> <th>0.639 ±</th> <th>0.689 ±</th> </tr> </thead> <tbody> <tr> <td rowspan="3">Color / Chromaticity Coordinates (IEC 1931)<sup>a</sup></td> <td>Green<sup>b</sup></td> <td>Ry<sup>c</sup></td> <td></td> <td></td> <td>0.283 ±</td> <td>0.333 ±</td> <td>0.383 ±</td> </tr> <tr> <td></td> <td>Gx<sup>c</sup></td> <td></td> <td></td> <td>0.252 ±</td> <td>0.302 ±</td> <td>0.352 ±</td> </tr> <tr> <td>Blue<sup>b</sup></td> <td>Gy<sup>c</sup></td> <td></td> <td></td> <td>0.574 ±</td> <td>0.624 ±</td> <td>0.674 ±</td> </tr> <tr> <td></td> <td>Bx<sup>e</sup></td> <td></td> <td></td> <td>0.107 ±</td> <td>0.157 ±</td> <td>0.207 ±</td> </tr> <tr> <td></td> <td>By<sup>e</sup></td> <td></td> <td></td> <td>0.006 ±</td> <td>0.056 ±</td> <td>0.106 ±</td> </tr> <tr> <td></td> <td>Ww<sup>e</sup></td> <td></td> <td></td> <td>0.263 ±</td> <td>0.313 ±</td> <td>0.363 ±</td> </tr> <tr> <td>White<sup>b</sup></td> <td>Wy<sup>e</sup></td> <td></td> <td></td> <td>0.279 ±</td> <td>0.329 ±</td> <td>0.379 ±</td> </tr> </tbody> </table>			Red <sup>d</sup>	Bx <sup>e</sup>		0.589 ±	0.639 ±	0.689 ±	Color / Chromaticity Coordinates (IEC 1931) <sup>a</sup>	Green <sup>b</sup>	Ry <sup>c</sup>			0.283 ±	0.333 ±	0.383 ±		Gx <sup>c</sup>			0.252 ±	0.302 ±	0.352 ±	Blue <sup>b</sup>	Gy <sup>c</sup>			0.574 ±	0.624 ±	0.674 ±		Bx <sup>e</sup>			0.107 ±	0.157 ±	0.207 ±		By <sup>e</sup>			0.006 ±	0.056 ±	0.106 ±		Ww <sup>e</sup>			0.263 ±	0.313 ±	0.363 ±	White <sup>b</sup>	Wy <sup>e</sup>			0.279 ±	0.329 ±	0.379 ±
		Red <sup>d</sup>	Bx <sup>e</sup>		0.590 ±	0.640 ±	0.690 ±																																																																																																																	
Color / Chromaticity Coordinates (IEC 1931) <sup>a</sup>	Green <sup>b</sup>	Ry <sup>c</sup>			0.283 ±	0.333 ±	0.383 ±																																																																																																																	
		Gx <sup>c</sup>			0.252 ±	0.302 ±	0.352 ±																																																																																																																	
	Blue <sup>b</sup>	Gy <sup>c</sup>			0.578 ±	0.628 ±	0.678 ±																																																																																																																	
	Bx <sup>e</sup>			0.107 ±	0.157 ±	0.207 ±																																																																																																																		
	By <sup>e</sup>			0.000 ±	0.050 ±	0.100 ±																																																																																																																		
	Ww <sup>e</sup>			0.2630	0.313 <sup>a</sup>	0.363 <sup>a</sup>																																																																																																																		
White <sup>b</sup>	Wy <sup>e</sup>			0.279 <sup>a</sup>	0.329 <sup>a</sup>	0.379 <sup>a</sup>																																																																																																																		
		Red <sup>d</sup>	Bx <sup>e</sup>		0.589 ±	0.639 ±	0.689 ±																																																																																																																	
Color / Chromaticity Coordinates (IEC 1931) <sup>a</sup>	Green <sup>b</sup>	Ry <sup>c</sup>			0.283 ±	0.333 ±	0.383 ±																																																																																																																	
		Gx <sup>c</sup>			0.252 ±	0.302 ±	0.352 ±																																																																																																																	
	Blue <sup>b</sup>	Gy <sup>c</sup>			0.574 ±	0.624 ±	0.674 ±																																																																																																																	
	Bx <sup>e</sup>			0.107 ±	0.157 ±	0.207 ±																																																																																																																		
	By <sup>e</sup>			0.006 ±	0.056 ±	0.106 ±																																																																																																																		
	Ww <sup>e</sup>			0.263 ±	0.313 ±	0.363 ±																																																																																																																		
White <sup>b</sup>	Wy <sup>e</sup>			0.279 ±	0.329 ±	0.379 ±																																																																																																																		

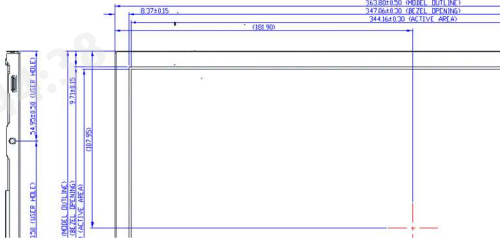
Version	Date	Page	Old description	New Description
1.2	2018/01/22	25	8.2 LCM Outline Dimension (Rear View) 	Remove 1 above connector&position circle 
1.3	2019/09/09	18	Note1	Update Note1: Due to PCB silkscreen PIN 1 printing error, please follow spec mark.
		25	8.2 LCM Outline Dimension (Rear View)	Update Note: Due to PCB silkscreen PIN 1 printing error, please follow spec mark.
1.4	2020/11/23	22	8.1 LCM Outline Dimension (Front View) 	

## 1. Handling Precautions

- 1) Since front polarizer is easily damaged, please be cautious and not to scratch it.
- 2) Be sure to turn off power supply when inserting or disconnecting from input connector.
- 3) Wipe off water drop immediately. Long contact with water may cause discoloration or spots.
- 4) When the panel surface is soiled, wipe it with absorbent cotton or soft cloth.
- 5) Since the panel is made of glass, it may be broken or cracked if dropped or bumped on hard surface.
- 6) To avoid ESD (Electro Static Discharge) damage, be sure to ground yourself before handling TFT-LCD Module.
- 7) Do not open nor modify the module assembly.
- 8) Do not press the reflector sheet at the back of the module to any direction.
- 9) In case if a module has to be put back into the packing container slot after it was taken out from the container, do not press the center of the LED light bar edge. Instead, press at the far ends of the LED light bar edge softly. Otherwise the TFT Module may be damaged.
- 10) At the insertion or removal of the Signal Interface Connector, be sure not to rotate nor tilt the Interface Connector of the TFT Module.
- 11) TFT-LCD Module is not allowed to be twisted & bent even force is added on module in a very short time. Please design your display product well to avoid external force applying to module by end-user directly.
- 12) Small amount of materials having no flammability grade is used in the LCD module. The LCD module should be supplied by power complied with requirements of Limited Power Source (IEC60950 or UL1950), or be applied exemption.
- 13) Severe temperature condition may result in different luminance, response time and lamp ignition voltage.
- 14) Continuous operating TFT-LCD display under low temperature environment may accelerate lamp exhaustion and reduce luminance dramatically.
- 15) The data on this specification sheet is applicable when LCD module is placed in landscape position.
- 16) Continuous displaying fixed pattern may induce image sticking. It's recommended to use screen saver or shuffle content periodically if fixed pattern is displayed on the screen.

## 2. General Description

G156HAN02.0 is a Color Active Matrix Liquid Crystal Display composed of a TFT LCD panel, a driver circuit, and LED backlight system. The screen format is intended to support the 16:9 FHD,

1920(H) x 1080(V) screen and 16.2M colors (RGB 6-bits + FRC)with LED backlight driving circuit. All input signals are eDP(Embedded DisplayPort) interface compatible.

G156HAN02.0 is designed for a display unit of notebook style personal computer and industrial machine.

## 2.1 General Specification

The following items are characteristics summary on the table at 25 °C condition:

Items	Unit	Specifications			
Screen Diagonal	[mm]	15.6"			
Active Area	[mm]	344.16 x 193.59			
Resolution		1920 x 3(RGB) x 1080			
Pixel Pitch	[mm]	0.17925 x 0.17925			
Pixel Arrangement		R.G.B. Vertical Stripe			
Display Mode		AHVA, Normally Black			
Nominal Input Voltage VDD	[Volt]	+3.3 (Typ.)			
LCD Power Consumption	[Watt]	0.98 (Max.)			
LED Power Consumption	[Watt]	10.4 (Max.)			
Weight	[Grams]	600 (Typ),660 (Max)			
Physical Size Include bracket	[mm]		Min.	Typ.	Max.
		Length	363.3	363.8	364.3
		Width	215.4	215.9	216.4
		Thickness		8.8	
Electrical Interface		2 Lane eDP			
Surface Treatment		Anti-glare, 3H			
Support Color		16.2M colors ( RGB 6-bits+FRC )			
Temperature Range					
	Operating	[°C]	-20 to +70 (+70°C as panel surface temperature)		
Storage (Non-Operating)	[°C]	-20 to +70			
RoHS Compliance		Yes			

## 2.2 Optical Characteristics

The optical characteristics are measured under stable conditions at 25°C (Room Temperature) :





Item	Unit	Conditions	Min.	Typ.	Max.	Note
White Luminance	cd/m <sup>2</sup>	I <sub>LED</sub> =50mA Center average	400	500	-	1, 2
Luminance Uniformity	%	9 Points	75	80		1, 2, 3
Contrast Ratio	--		700	1000	-	1, 4
Response Time	msec	Rising + Falling	-	25	35	1, 5
Viewing Angle	degree	Horizontal (Right) CR = 10 (Left)	80 80	89 89	- -	1, 6
		Vertical (Upper) CR = 10 (Lower)	80 80	89 89	- -	
Color / Chromaticity Coordinates (CIE 1931)	Red	Rx	0.589	0.639	0.689	4
		Ry	0.283	0.333	0.383	
	Green	Gx	0.252	0.302	0.352	
		Gy	0.574	0.624	0.674	
	Blue	Bx	0.107	0.157	0.207	
		By	0.008	0.058	0.108	
	White	Wx	0.263	0.313	0.363	
		Wy	0.279	0.329	0.379	
Color Gamut		%	-	72	-	

Note 1: Measurement method

Equipment Pattern Generator, Power Supply, Digital Voltmeter, Luminance meter (SR\_3 or equivalent)

- Aperture 1° with 50cm viewing distance
- Test Point Center
- Environment < 1 lux

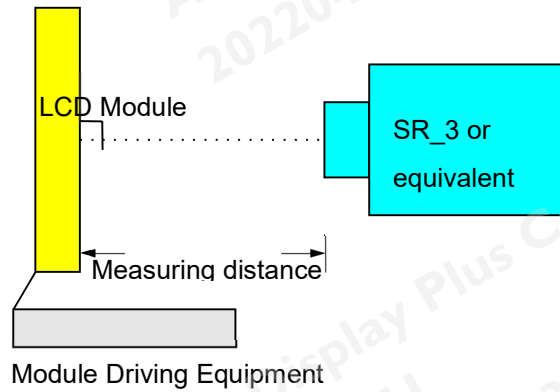

Note 2: 9 points position

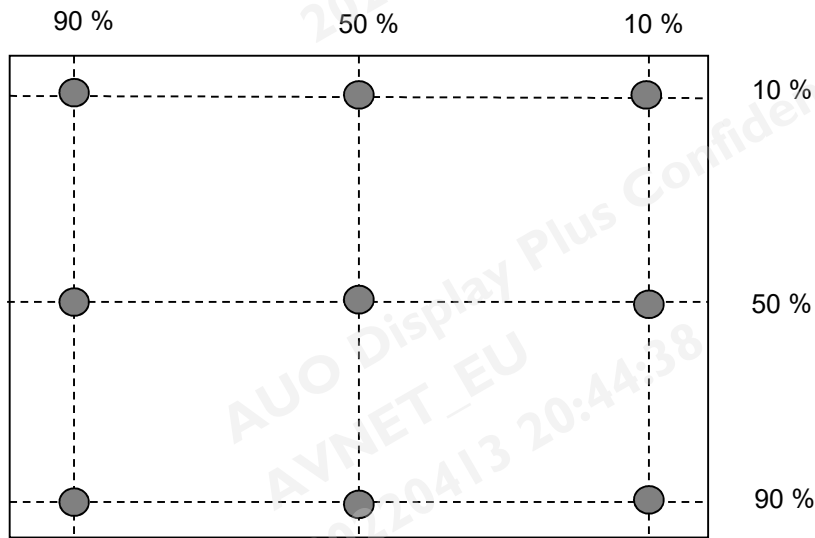

Note 3: The luminance uniformity of 9 points is defined by dividing the maximum luminance values by the minimum test point luminance. And measured by TOPCON SR-3

$$\delta w_9 = \frac{\text{Minimum Luminance of 9 points}}{\text{Maximum Luminance of 9 points}}$$



**Note 4 :** Definition of contrast ratio:

Contrast ratio is calculated with the following formula.

$$\text{Contrast ratio (CR)} = \frac{\text{Brightness on the "White" state}}{\text{Brightness on the "Black" state}}$$

**Note 5:** Definition of response time:

The output signals of BM-7 or equivalent are measured when the input signals are changed from "Black" to "White" (falling time) and from "White" to "Black" (rising time), respectively. The response time interval between the 10% and 90% of amplitudes. Refer to figure as below.

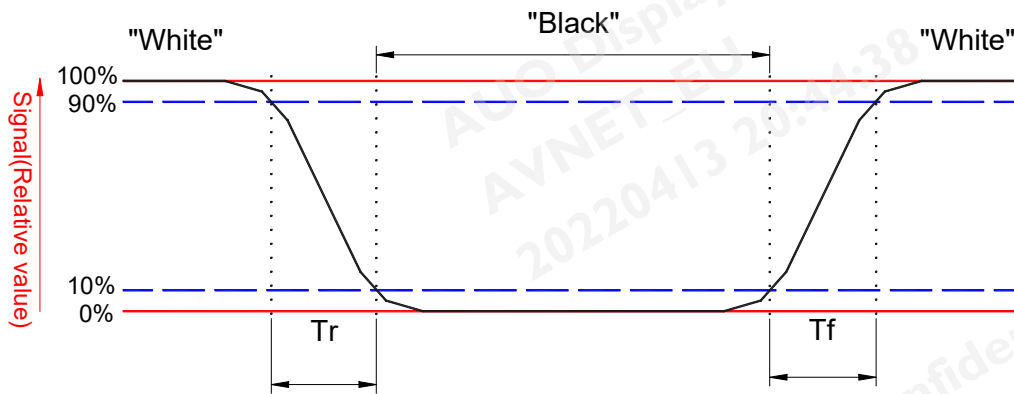

**Note 6:** Definition of viewing angle

Viewing angle is the measurement of contrast ratio  $\geq 10$ , at the screen center, over a 180° horizontal and 180° vertical range (off-normal viewing angles). The 180° viewing angle range is broken down as follows; 90° ( $\theta$ ) horizontal left and right and 90° ( $\Phi$ ) vertical, high (up) and low (down). The measurement direction is typically perpendicular to the display surface with the screen rotated about its center to develop the desired measurement viewing angle.

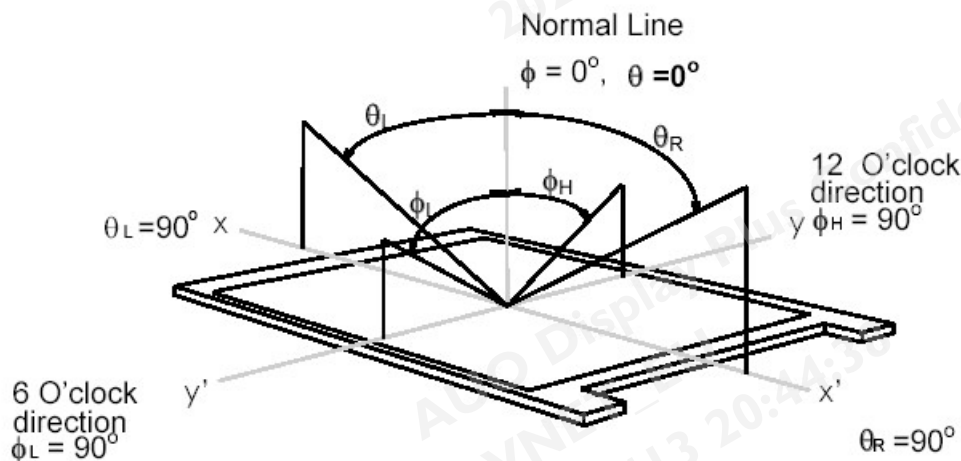

## 3. Functional Block Diagram

The following diagram shows the functional block of the 15.6 inches wide Color TFT/LCD module.

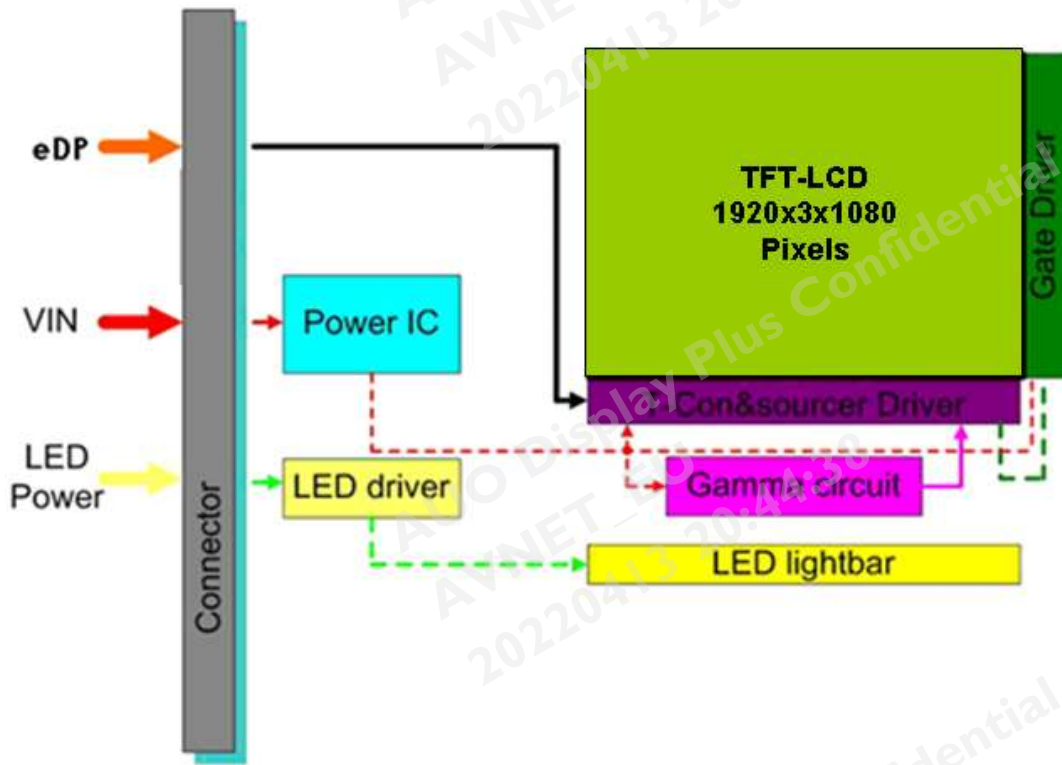

## 4. Absolute Maximum Ratings

An absolute maximum rating of the module is as following:

### 4.1 Absolute Ratings of TFT LCD Module

Item	Symbol	Min	Max	Unit
Logic/LCD Drive	Vin	-0.3	+4.0	[Volt]

### 4.2 Absolute Ratings of Environment

Item	Symbol	Min	Max	Unit
Operating	TOP	-20	+70	[°C]
Operation Humidity	HOP	5	95	[%RH]
Storage Temperature	TST	-20	+70	[°C]
Storage Humidity	HST	5	95	[%RH]

Note: Maximum Wet-Bulb should be 39 °C and no condensation.

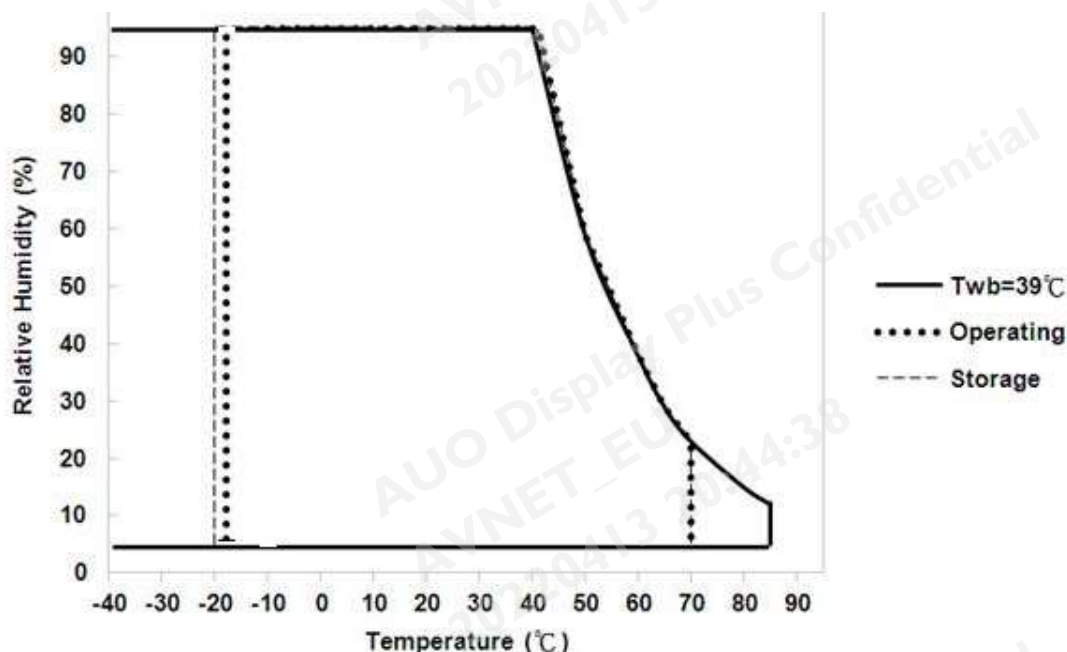

## 5. Electrical Characteristics

### 5.1 TFT LCD Module

#### 5.1.1 Power Specification

Input power specifications are as follows;

The power specification are measured under 25°C and frame frequency under 60Hz

Symbol	Parameter	Min	Typ	Max	Units	Remark
VDD	Logic/LCD Drive Voltage	3.0	3.3	3.6	[Volt]	
PDD	VDD Power	-	0.79	0.98	[Watt]	All Black Pattern (VDD=3.3V, at 60Hz)
IDD	IDD Current	-	240	290	[mA]	All Black Pattern (VDD=3.3V, at 60Hz)
IRush	Inrush Current	-	-	2000	[mA]	Note 1
VDDrp	Allowable Logic/LCD Drive Ripple Voltage	-	-	100	[mV] p-p	All Black Pattern (VDD=3.3V, at 60Hz)

Note 1 : Maximum Measurement Condition : White Pattern at 3.3V driving voltage. ( $P_{max}=V_{3.3} \times I_{white}$ )

Typical Measurement Condition: Mosaic Pattern

Note 2 : Measure Condition

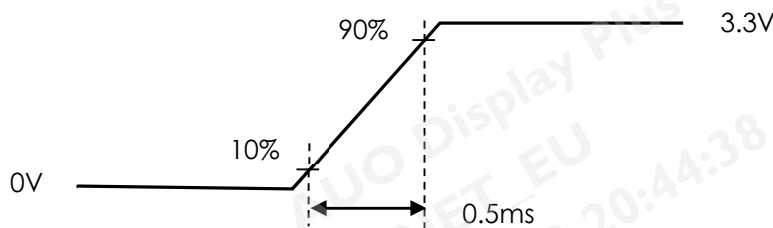
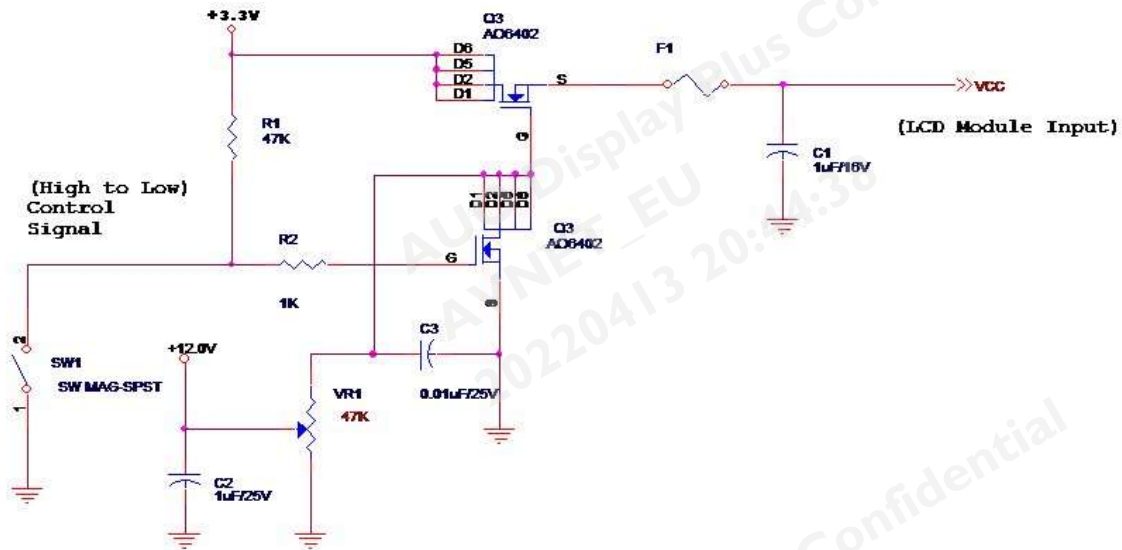

Vin rising time

## 5.1.2 Signal Electrical Characteristics

Input signals shall be low or High-impedance state when VDD is off.

Signal electrical characteristics are as follows;

### Display Port main link signal:

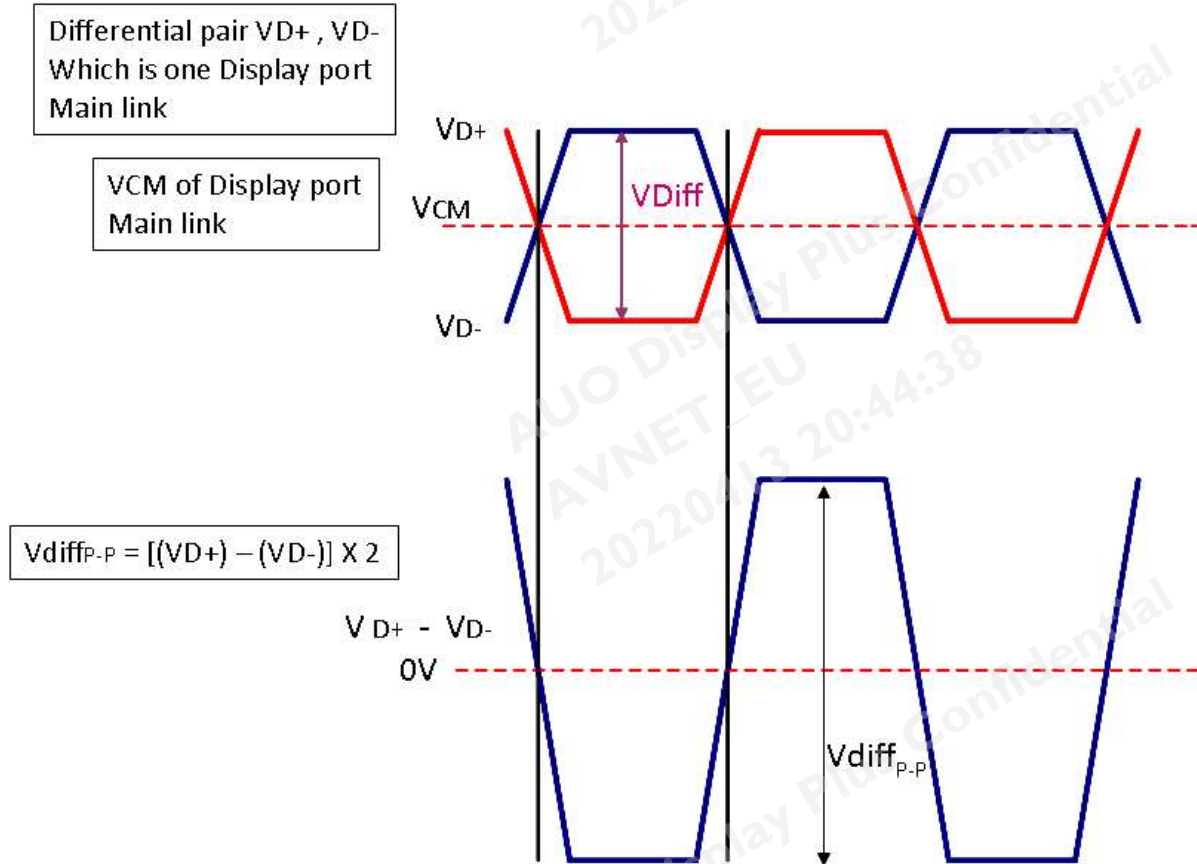

Display port main link					
		Min	Typ	Max	unit
VCM	RX input DC Common Mode Voltage		0		V
VDiff <sub>P-P</sub>	Peak-to-peak Voltage at a receiving Device	100		1320	mV

Fallow as VESA display port standard V1.1a

## Display Port AUX\_CH signal:

Differential AUX+ , AUX-  
Which is Display port AUX\_CH

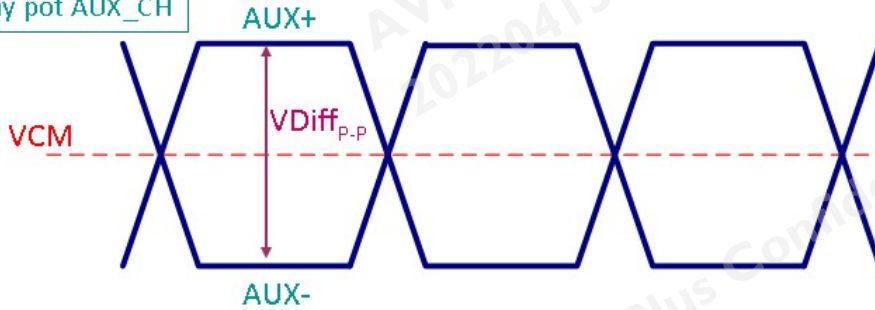

Display port AUX_CH					
		Min	Typ	Max	unit
VCM	AUX DC Common Mode Voltage		0		V
VDiff <sub>p-p</sub>	AUX Peak-to-peak Voltage at a receiving Device	0.4	0.6	0.8	V

Fallow as VESA display port standard V1.1a.

## Display Port VHPD signal:

Display port VHPD					
		Min	Typ	Max	unit
VHPD	HPD Voltage	2.25		3.6	V

Fallow as VESA display port standard V1.1a.





## 5.2 Backlight Unit

### 5.2.1 LED characteristics

Parameter	Symbol	Min	Typ	Max	Units	Condition
Backlight Power Consumption	PLED	-	8.3	10.4	[Watt]	(Ta=25°C), Note 1 Vin =12V
LED Life-Time	N/A	50,000	-	-	Hour	(Ta=25°C), Note 2,3

**Note 1:** Ta means ambient temperature of TFT-LCD module.

**Note 2:** If G156HAN02.0 module is driven at high ambient temperature & humidity condition. The operating life will be reduced.

**Note 3:** Operating life means brightness goes down to 50% initial brightness. Min. operating life time is estimated data.

### 5.2.2 Backlight input signal characteristics

Parameter	Symbol	Min	Typ	Max	Units	Remark
LED Power Supply	VLED	10.8	12	13.2	[Volt]	Define as Connector Interface (Ta=25°C)
LED Enable Input High Level	VLED_EN	2.5		5.5	[Volt]	
LED Enable Input Low Level		0		0.9	[Volt]	
PWM Logic Input High Level	VPWM_EN	2.5		5.5	[Volt]	
PWM Logic Input Low Level		0		0.9	[Volt]	
PWM Input Frequency	FPWM	200		15K	Hz	
PWM Duty Ratio	Duty	10		100	%	

**Note 1 :** Recommended system pull up/down resistor no bigger than 10kohm.

**Note 2 :** If the PWM duty ratio(min) is set between 5% to 1% , the PWM input frequency should be set below 1KHz . The brightness-duty characteristic might not be able to keep in it's linearity if the dimming control is operated in 1% to 5% range.



## 6. Signal Interface Characteristic

### 6.1 Pixel Format Image

Following figure shows the relationship of the input signals and LCD pixel format.

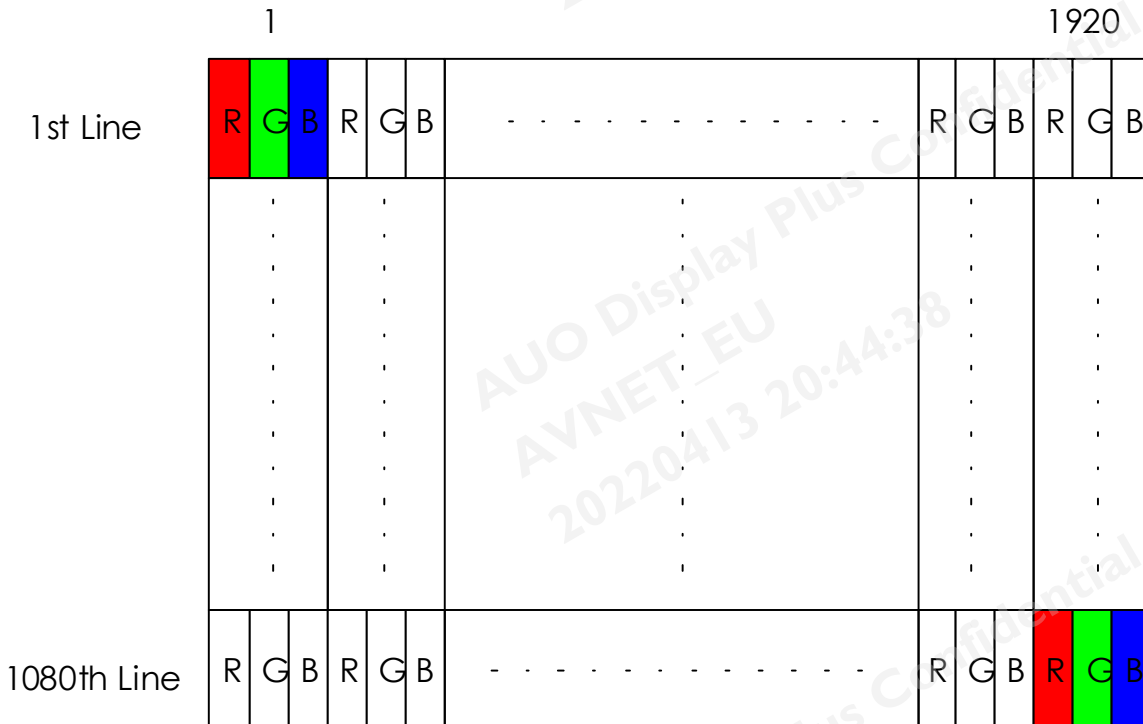

## 6.2 Integration Interface Requirement

### 6.2.1 Connector Description

Physical interface is described as for the connector on module.

These connectors are capable of accommodating the following signals and will be following components.

Connector Name / Designation	For Signal Connector
Manufacturer	IPEX or compatible
Type / Part Number	IPEX 20455-030E-76B or compatible
Mating Housing/Part Number	IPEX 20453-030T-11 or compatible

### 6.2.2 Pin Assignment (2 Lane)

eDP lane is a differential signal technology for LCD interface and high speed data transfer device.

PIN No	Symbol	Function
1	NC	Reverse for AUO TEST only
2	H_GND	High Speed Ground
3	Lane1_N	Comp Signal Lane 1
4	Lane1_P	True Signal Link Lane 1
5	H_GND	High Speed Ground
6	Lane0_N	Comp Signal Link Lane 0
7	Lane0_P	True Signal Link Lane 0
8	H_GND	High Speed Ground
9	AUX_CH_P	True Signal Auxiliary Ch.
10	AUX_CH_N	Comp Signal Auxiliary Ch.
11	H_GND	High Speed Ground
12	LCD_VCC	LCD logic and driver power
13	LCD_VCC	LCD logic and driver power
14	LCD_Self_Test or NC	LCD Panel Self Test Enable (Optional)
15	LCD_GND	LCD logic and driver ground
16	LCD_GND	LCD logic and driver ground
17	HPD	HPD signal pin
18	BL_GND	Backlight_ground
19	BL_GND	Backlight_ground
20	BL_GND	Backlight_ground
21	BL_GND	Backlight_ground
22	BL_Enable	Backlight On / Off
23	BL_PWM_DIM	System PWM signal Input
24	NC	Reverse for AUO TEST only
25	NC	Reverse for AUO TEST only
26	BL_PWR	Backlight power (5V~21V)
27	BL_PWR	Backlight power (5V~21V)
28	BL_PWR	Backlight power (5V~21V)
29	BL_PWR	Backlight power (5V~21V)
30	NC	No Connect (Reserved for CM)

**Note1** : start from right side refer to next page illustration. Due to PCB silkscreen PIN 1 printing error, please follow spec mark.

**Note2** : Input signals shall be low or High-impedance state when VDD is off.  
Internal circuit of **eDP inputs** are as following.

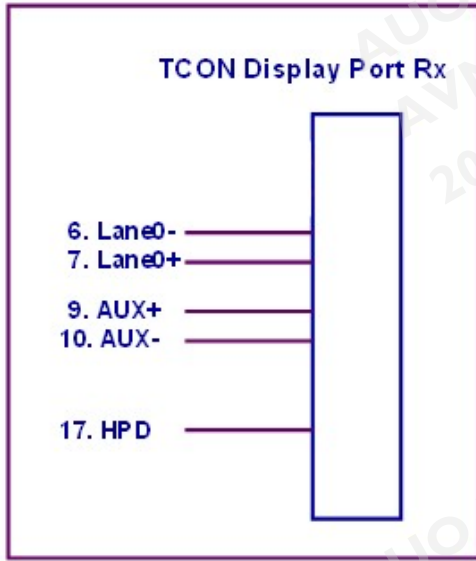

**Note3** : Connector Illustration

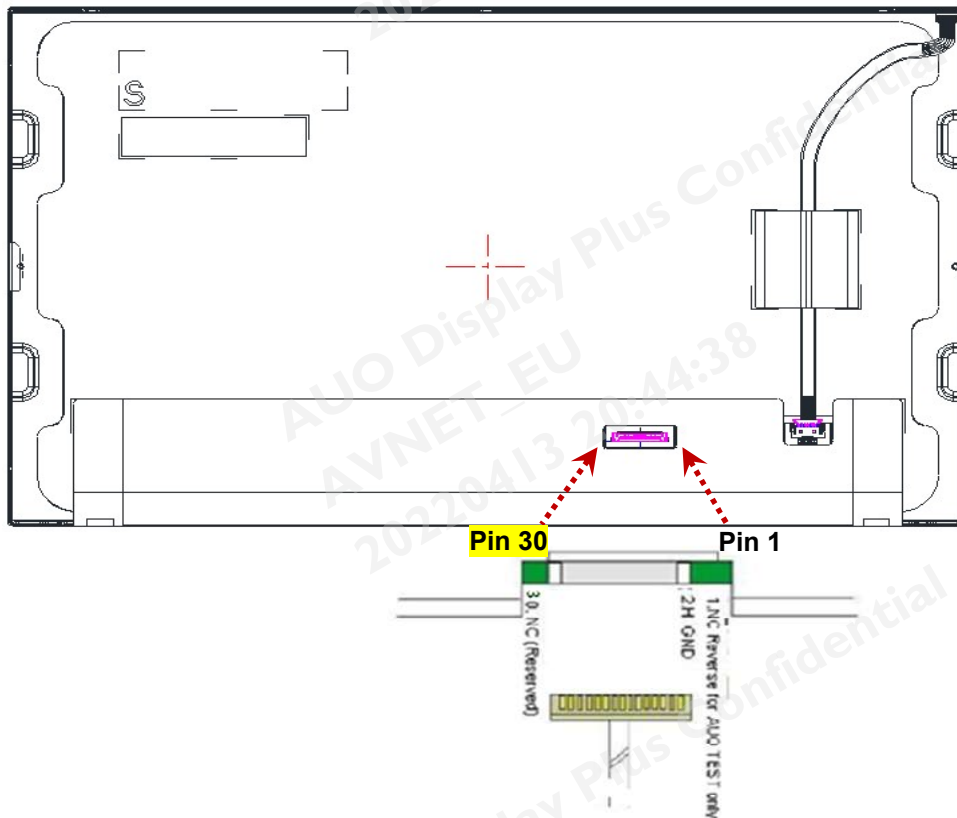

\*\*Due to PCB silkscreen PIN 1 printing error, please follow spec mark.

## 6.3 Interface Timing

### 6.3.1 Timing Characteristics

Basically, interface timings should match the 1920x1080 /60Hz manufacturing guide line timing.

Parameter		Symbol	Min.	Typ.	Max.	Unit
Frame Rate		-	-	60	-	Hz
Clock frequency		1/ T <sub>clock</sub>	-	141	-	MHz
Vertical Section	Period	T <sub>V</sub>	1090	1116	1880	T <sub>Line</sub>
	Active	T <sub>VD</sub>	1080			
	Blanking	T <sub>VB</sub>	10	36	800	
Horizontal Section	Period	T <sub>H</sub>	2080	2104	2320	T <sub>clock</sub>
	Active	T <sub>HD</sub>	1920			
	Blanking	T <sub>HB</sub>	160	184	400	

**Note 1** : DE mode only

**Note 2** : The maximum clock frequency = (960+B)\*(1080+A)\*60 < 80MHz

## 6.4 Power ON/OFF Sequence

Power on/off sequence is as follows. Interface signals and LED on/off sequence are also shown in the chart.

Signals from any system shall be Hi-Z state or low level when VDD is off

**Display Port panel power sequence:**

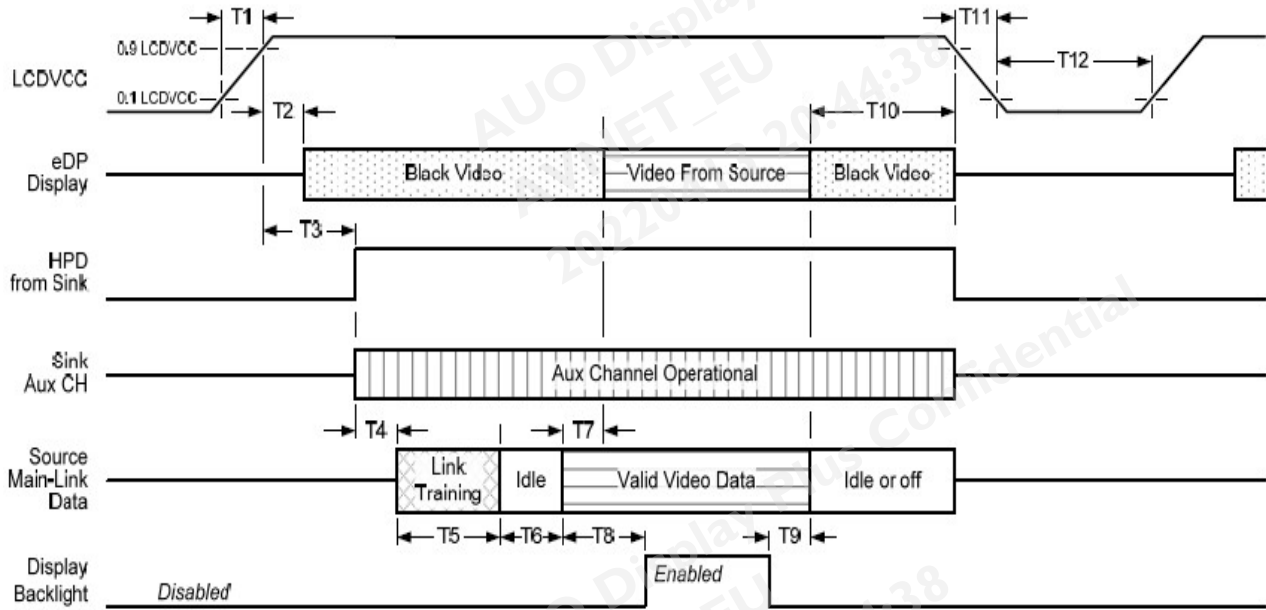

**Display port interface power up/down sequence, normal system operation**

**Display Port AUX\_CH transaction only:**

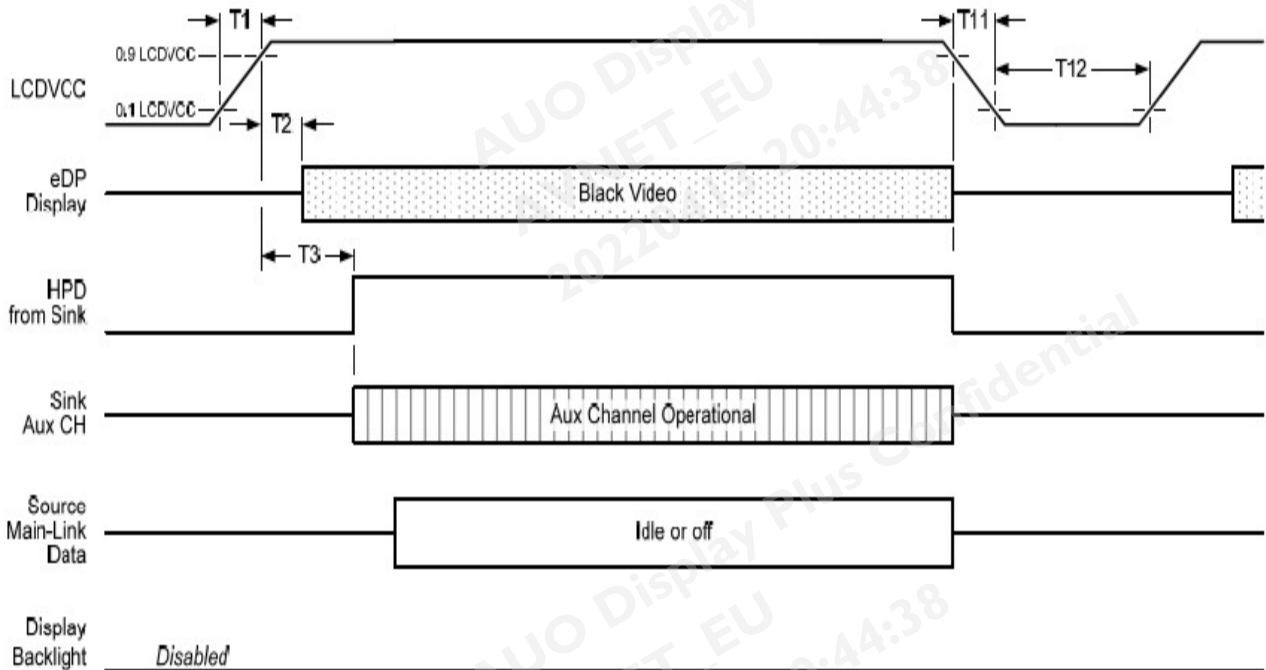

**Display port interface power up/down sequence, AUX\_CH transaction only**



**Display Port panel power sequence timing parameter:**

Timing parameter	Description	Reqd. by	Limits			Notes
			Min.	Typ.	Max.	
T1	power rail rise time, 10% to 90%	source	0.5ms		10ms	
T2	delay from LCDVDD to black video generation	sink	0ms		200ms	prevents display noise until valid video data is received from the source
T3	delay from LCDVDD to HPD high	sink	0ms		200ms	sink AUX_CH must be operational upon HPD high.
T4	delay from HPD high to link training initialization	source				allows for source to read link capability and initialize.
T5	link training duration	source				dependant on source link to read training protocol.
T6	link idle	source				Min accounts for required BS-Idle pattern. Max allows for source frame synchronization.
T7	delay from valid video data from source to video on display	sink	0ms		50ms	max allows sink validate video data and timing.
T8	delay from valid video data from source to backlight enable	source				source must assure display video is stable.
T9	delay from backlight disable to end of valid video data	source				source must assure backlight is no longer illuminated.
T10	delay from end of valid video data from source to power off	source	0ms		500ms	
T11	power rail fall time, 90% to 10%	source			10ms	
T12	power off time	source	500ms			

**Note 1:** The sink must include the ability to generate black video autonomously. The sink must automatically enable black video under the following conditions:  
 -upon LCDVDD power on (with in T2 max)-when the "Novideostream\_Flag" (VB-ID Bit 3) is received from the source (at the end of T9).  
 -when no main link data, or invalid video data, is received from the source. Black video must be displayed within 64ms (typ) from the start of either condition. Video data can be deemed invalid based on MSA and timing information, for example.

**Note 2:** The sink may implement the ability to disable the black video function, as described in Note 1, above, for system development and debugging purpose.

**Note 3:** The sink must support AUX\_CH polling by the source immediately following LCD VDD power on without causing damage to the sink device (the source can re-try if the sink is not ready). The sink must be able to respond to an AUX\_CH transaction with the time specified within T3 max.

**Display Port panel B/L power sequence timing parameter:**

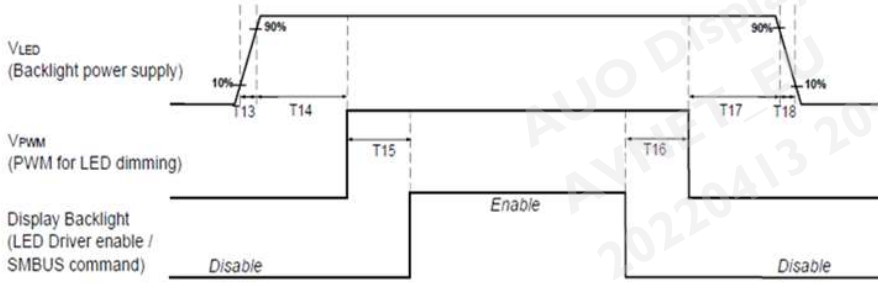

	Min (ms)	Max (ms)
T13	0.5	10
T14	10	-
T15	10	-
T16	10	-
T17	10	-
T18	0.5	10
T19	1*	-
T20	1*	-

Note : When the adapter is hot plugged, the backlight power supply sequence is shown as below.

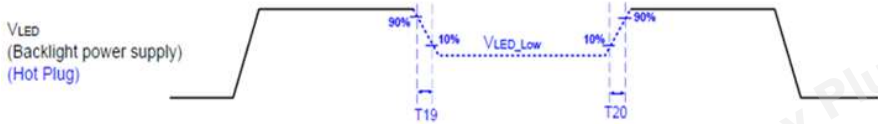

Seamless change:  $T19/T20 = 5 \times T_{PWM}^*$   
 $T_{PWM}^* = 1/PWM \text{ Frequency}$

## 7. Panel Reliability Test



Items	Required Condition	Note
Temperature Humidity Bias	Ta= 50°C , 80%RH, 300h	Note 1,2
High Temperature Operation	Ta= 70°C , Dry, 300h (For panel surface temp.)	
Low Temperature Operation	Ta= -20°C , 300h	
High Temperature Storage	Ta= 70°C , 300h	
Low Temperature Storage	Ta= -20°C , 300h	
Thermal Shock Test	Ta= -20°C to 60°C , Duration at 30 min, 100 cycles	
Vibration	Test method: Non-Operation Acceleration: 1.5 G Frequency: 10 - 200 -10Hz Sweep: Sine wave vibration; 30 minutes each axis (X, Y, Z)	
Mechanical Shock	Test method: Non-Operation Acceleration: 50 G; Wave: Half-sine Active time: 20 ms Direction: ±X,±Y,±Z (one time for each axis)	
Drop Test	Height: 46 cm, package test	
ESD	Contact : ±8 KV Air : ±15 KV	Note 1

**Note 1:** According to EN 61000-4-2 , ESD class B: Some performance degradation allowed. Self-recoverable. No data lost, No hardware failures.

**Note 2:**

- Water condensation is not allowed for each test items.
- Each test is done by new TFT-LCD module. Don't use the same TFT-LCD module repeatedly for reliability test.
- The reliability test is performed only to examine the TFT-LCD module capability.
- To inspect TFT-LCD module after reliability test, please store it at room temperature and room humidity for 24 hours at least in advance.
- No function failure occurs. Mura shall be ignored after high temperature reliability test



## 8.2 LCM Outline Dimension (Rear View)

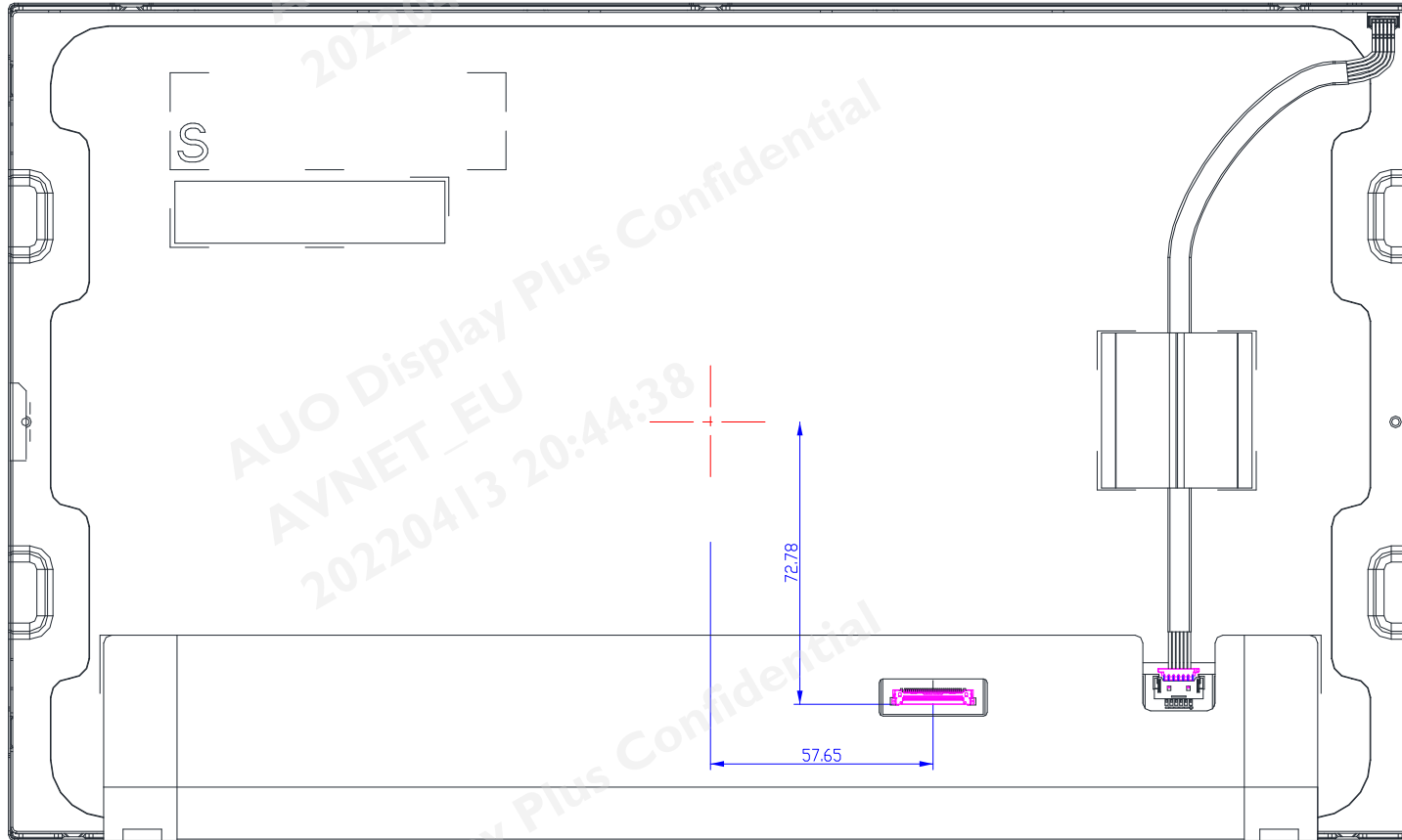

Remark: Due to PCB silkscreen PIN 1 printing error, please follow spec mark at page18.

## 9. Shipping and Package

### 9.1 Shipping Label Format



**Note 1:** For Pb Free products, AUO will add  for identification.

**Note 2:** For RoHS compatible products, AUO will add  for identification.

**Note 3:** For China RoHS compatible products, AUO will add  for identification.

**Note 4:** The Green Mark will be presented only when the green documents have been ready by AUO Internal Green Team.

## 9.2 Carton Package

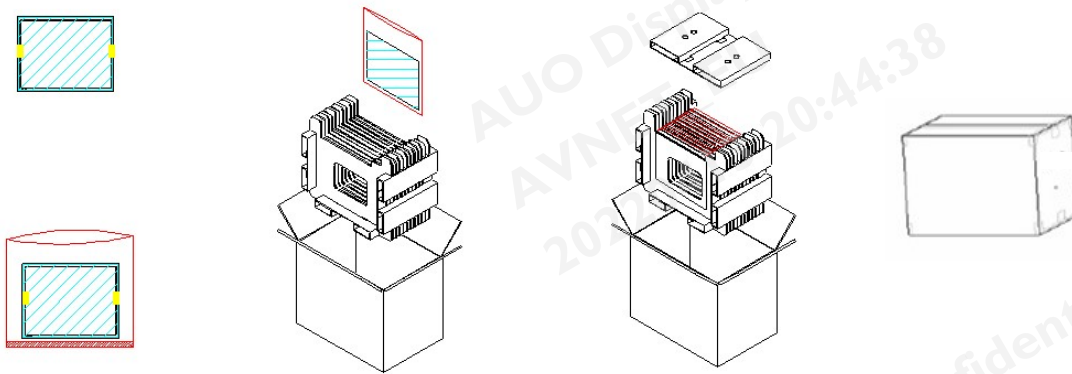

Max capacity : 16 TFT-LCD module per carton

Max weight: 13.2 kg per carton

Outside dimension of carton: 450mm(L)\*375mm(W)\*319mm(H)

Pallet size : 1150 mm \* 910 mm \* 132mm

### Box stacked

Module by air :  $(2 * 3) * 4$  layers , one pallet put 24 boxes , total 384pcs module

Module by sea :  $(2 * 3) * 4$  layers+ $(2 * 3) * 1$  layers , two pallet put 30 boxes , total 480pcs module

Module by sea\_HQ :  $(2 * 3) * 4$  layers+ $(2 * 3) * 2$  layers , two pallet put 42 boxes , total 576 pcs module

## 9.3 Shipping Package of Palletizing Sequence

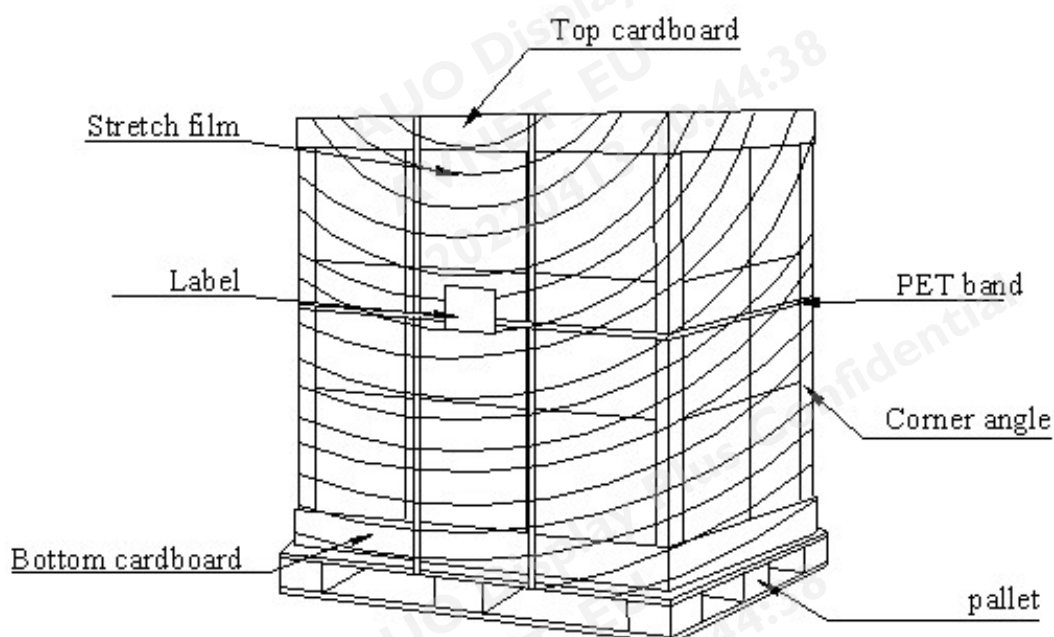

## 10. Handling guide

This is a LCD model, and please be cautious when pulling it out of package or assembling it onto platform. Careless handlings, e.g. twist, bending, pressing, or collision, will result malfunction of LCD models.

### (1) Handling method notice



Do not lift and hold the panel with single hand at right or left side from tray.



Lift and hold the panel up with both hands from tray.

### (2) On the table notice



Do not press edge of panel to avoid glass broken.



Do not press the surface of the panel to avoid the glass broken or polarizer scratch.





Do not put anything or tool on the panel to avoid the glass broken or polarizer scratch.

### (3) Cable assembly notice



Do not insert the connector with single hand and touching the PCBA.



Insert the connector by pushing right and left edge.



## 11. Appendix: EDID Description

Address	FUNCTION	Value	Value	Value	Note
HEX		HEX	BIN	DEC	
00	Header	00	00000000	0	
01		FF	11111111	255	
02		FF	11111111	255	
03		FF	11111111	255	
04		FF	11111111	255	
05		FF	11111111	255	
06		FF	11111111	255	
07		00	00000000	0	
08	EISA Manuf. Code LSB	06	00000110	6	
09	Compressed ASCII	AF	10101111	175	
0A	Product Code	ED	11101101	237	
0B	hex, LSB first	30	00110000	48	
0C	32-bit ser #	00	00000000	0	
0D		00	00000000	0	
0E		00	00000000	0	
0F		00	00000000	0	
10	Week of manufacture	21	00100001	33	
11	Year of manufacture	17	00010111	23	
12	EDID Structure Ver.	01	00000001	1	
13	EDID revision #	04	00000100	4	
14	<b>Video input def.</b> <i>(digital I/P, non-TMDS, CRGB)</i>	95	10010101	149	
15	<b>Max H image size</b> <i>(rounded to cm)</i>	22	00100010	34	
16	<b>Max V image size</b> <i>(rounded to cm)</i>	13	00010011	19	
17	<b>Display Gamma</b> <i>(=(gamma*100)-100)</i>	78	01111000	120	
18	<b>Feature support</b> <i>(no DPMS, Active OFF, RGB, tmg Blk#1)</i>	02	00000010	2	
19	Red/green low bits <b>(Lower 2:2:2 bits)</b>	E2	11100010	226	
1A	Blue/white low bits <b>(Lower 2:2:2 bits)</b>	95	10010101	149	
1B	Red x <b>(Upper 8 bits)</b>	A3	10100011	163	
1C	Red y/ highER 8 bits	54	01010100	84	
1D	Green x	52	01010010	82	
1E	Green y	99	10011001	153	
1F	Blue x	26	00100110	38	
20	Blue y	0F	00001111	15	
21	White x	50	01010000	80	
22	White y	54	01010100	84	
23	Established timing 1	00	00000000	0	
24	Established timing 2	00	00000000	0	
25	Established timing 3	00	00000000	0	
26	Standard timing #1	01	00000001	1	
27		01	00000001	1	
28	Standard timing #2	01	00000001	1	
29		01	00000001	1	
2A	Standard timing #3	01	00000001	1	
2B		01	00000001	1	

2C	Standard timing #4	01	00000001	1	
2D		01	00000001	1	
2E	Standard timing #5	01	00000001	1	
2F		01	00000001	1	
30	Standard timing #6	01	00000001	1	
31		01	00000001	1	
32	Standard timing #7	01	00000001	1	
33		01	00000001	1	
34	Standard timing #8	01	00000001	1	
35		01	00000001	1	
36	Pixel Clock/10000 LSB	14	00010100	20	
37	Pixel Clock/10000 USB	37	00110111	55	
38	Horz active <b>Lower 8bits</b>	80	10000000	128	
39	Horz blanking <b>Lower 8bits</b>	B8	10111000	184	
3A	HorzAct:HorzBlnk <b>Upper 4:4 bits</b>	70	01110000	112	
3B	Vertical Active <b>Lower 8bits</b>	38	00111000	56	
3C	Vertical Blanking <b>Lower 8bits</b>	24	00100100	36	
3D	Vert Act : Vertical Blanking <b>(upper 4:4 bit)</b>	40	01000000	64	
3E	HorzSync. Offset	10	00010000	16	
3F	HorzSync.Width	10	00010000	16	
40	VertSync.Offset : VertSync.Width	3E	00111110	62	
41	Horz&Vert Sync Offset/Width <b>Upper 2bits</b>	00	00000000	0	
42	Horizontal Image Size <b>Lower 8bits</b>	58	01011000	88	
43	Vertical Image Size <b>Lower 8bits</b>	C1	11000001	193	
44	Horizontal & Vertical Image Size <b>(upper 4:4 bits)</b>	10	00010000	16	
45	Horizontal Border <i>(zero for internal LCD)</i>	00	00000000	0	
46	Vertical Border <i>(zero for internal LCD)</i>	00	00000000	0	
47	Signal <i>(non-intr, norm, no stero, sep sync, neg pol)</i>	18	00011000	24	
48	Detailed timing/monitor	B8	10111000	184	
49	descriptor #2	24	00100100	36	
4A		80	10000000	128	
4B		B8	10111000	184	
4C		70	01110000	112	
4D		38	00111000	56	
4E		24	00100100	36	
4F		40	01000000	64	
50		10	00010000	16	
51		10	00010000	16	
52		3E	00111110	62	
53		00	00000000	0	
54		58	01011000	88	
55		C1	11000001	193	
56		10	00010000	16	
57		00	00000000	0	
58		00	00000000	0	
59		18	00011000	24	
5A	Detailed timing/monitor	00	00000000	0	
5B	descriptor #3	00	00000000	0	

5C		00	00000000	0	
5D		FE	11111110	254	
5E		00	00000000	0	
5F	Manufacture	41	01000001	65	A
60	Manufacture	55	01010101	85	U
61	Manufacture	4F	01001111	79	O
62		0A	00001010	10	
63		20	00100000	32	
64		20	00100000	32	
65		20	00100000	32	
66		20	00100000	32	
67		20	00100000	32	
68		20	00100000	32	
69		20	00100000	32	
6A		20	00100000	32	
6B		20	00100000	32	
6C	Detailed timing/monitor	00	00000000	0	
6D	descriptor #4	00	00000000	0	
6E		00	00000000	0	
6F		FE	11111110	254	
70		00	00000000	0	
71	Manufacture P/N	42	01000010	66	B
72	Manufacture P/N	31	00110001	49	1
73	Manufacture P/N	35	00110101	53	5
74	Manufacture P/N	36	00110110	54	6
75	Manufacture P/N	48	01001000	72	H
76	Manufacture P/N	41	01000001	65	A
77	Manufacture P/N	4E	01001110	78	N
78	Manufacture P/N	30	00110000	48	0
79	Manufacture P/N	33	00110011	51	3
7A	Manufacture P/N	2E	00101110	46	.
7B	Manufacture P/N	30	00110000	48	0
7C		20	00100000	32	
7D		0A	00001010	10	
7E	Extension Flag	00	00000000	0	
7F	Checksum	D9	11011001	217	